

Quick Ship

# Quick Ship

A carefully edited collection of drapery hardware.  
And you get it **fast . . .**

## Metal 1"

- metal finials you can accessorize
- 1" smooth metal poles *or* 1" Hand Drawn Traverse System
- 5 Quick Ship Metal finishes



## Luxe Line

- flat rail Hand Drawn Traverse System
- 3 Luxe Line finishes



## Wood and Resin 1 3/8"

- 1 3/8" smooth or fluted wood poles
- 5 Quick Ship Wood and Resin finishes



## Wood and Resin 2 1/4"

- 2 1/4" smooth or fluted wood poles
- 5 Quick Ship Wood and Resin finishes



**1 business day lead time**

Quick Ship  
Metal  
1"

Quick Ship METAL FINISHES



BRUSHED NICKEL  
QSBN



MIDNIGHT  
QSMID



ROSE GOLD  
QSRG

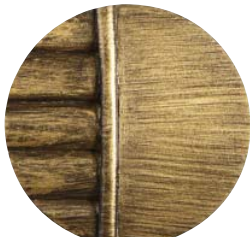

ANTIQUE BRASS  
QSAB



OIL RUBBED BRONZE  
QSORB

QUICK SHIP Metal 1" .....> [Orders received by noon CST ship the same day!]

8 classic shapes. 4 gorgeous styles.  
Plus, a great little end cap that goes with every style!

## Modern

Modern Metal Finials

Located on page 72



## Make It Glamorous!

Add a 1" Crystal Band

Located on page 73



The Modern Metal Finials and the 1" Crystal Band fit the 1" Metal Pole.

*The 1" Crystal Band is a Finial Accessory. Position it next to a Modern Metal Finial or anywhere on the 1" Metal Pole for a sparkling treatment.*

Oh, and did we mention . . . ?

# 1" Metal now has a Hand Drawn Traverse track.

## Transitional

Transitional Metal Finials

Located on page 74

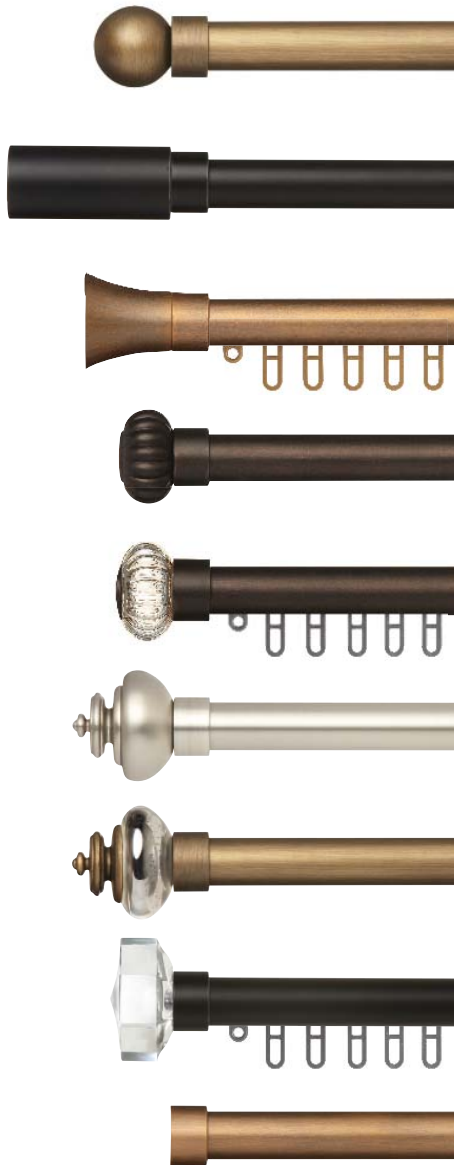

## Make It Traditional!

Add a Traditional Collar

Located on page 75

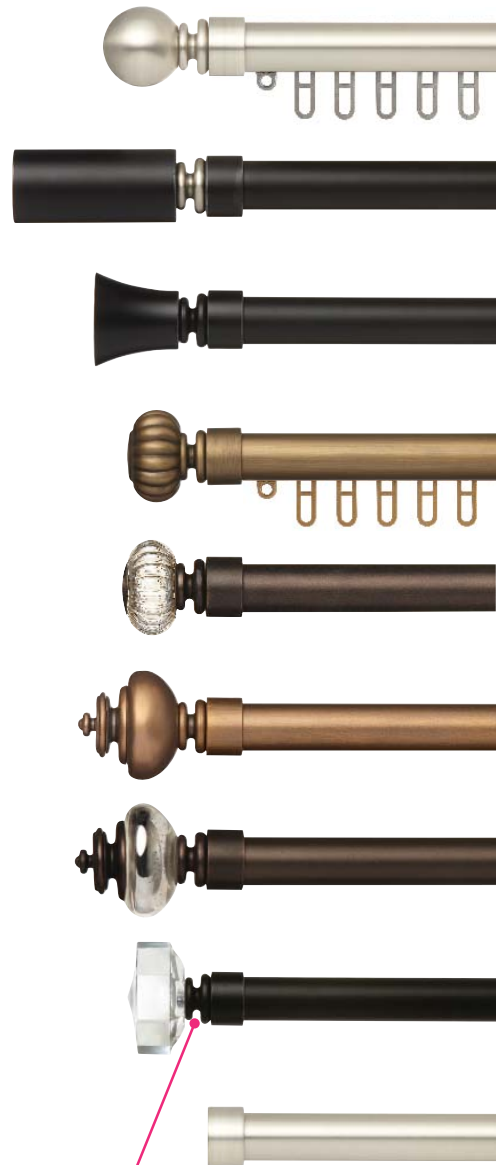

The Transitional Metal Finials fit the 1" Metal Pole and the 1" Hand Drawn Traverse System.

(1" Hand Drawn Traverse System, see pages 78-80.)

*The Collar is a Finial Accessory. Add it to the Transitional Metal Finial for a Traditional look.*

**QUICK SHIP Metal 1"** .....> [Orders received by noon CST ship the same day!]

# Modern Metals

Simple designs blend into any contemporary environment.



Lex Finial, Laurence 3" Single Bracket, and 1" Metal Rings shown in Rose Gold.

1" Modern Metal Finials *Not compatible with 1" Hand Drawn Traverse System.*

**\*Remember:**  
Luna End Cap covers 3/8" of the pole. Finished pole length may need to be increased accordingly.



**Luna End Cap\***  
QS100LUEC  
3/4" W  
1 1/2" DIA  
Midnight



**Ella**  
QS100ELAFI  
1 1/2" W  
1 3/8" DIA  
Oil Rubbed Bronze



**Lex**  
QS100LXFI  
1 3/4" W  
2" DIA  
Antique Brass



**Cole**  
QS100COFI  
3 1/4" W  
1 1/2" DIA  
Brushed Nickel



**Elm**  
QS100EMFI  
1 1/8" W  
2" DIA  
Midnight



**Nora**  
QS100NOFI  
2" W  
2 1/4" DIA  
Oil Rubbed Bronze



**Knox - Crystal**  
QS100KNFI  
1 1/2" W  
2 1/4" DIA  
pole shown in Antique Brass



**Elm - Smoke Glass**  
QS100EMFIGL  
1 1/8" W  
2" DIA  
Rose Gold



**Nora - Mercury Glass**  
QS100NOFIGL  
2 1/8" W  
2 3/8" DIA  
Brushed Nickel

1" Modern Metal Finials ARE AVAILABLE IN 5 QUICK SHIP METAL FINISHES:



BRUSHED NICKEL  
QSBN



MIDNIGHT  
QSMID



ROSE GOLD  
QSRG

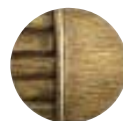

ANTIQUE BRASS  
QSAB



OIL RUBBED BRONZE  
QSORB

Don't forget:  
Bling can be  
added anywhere  
on the pole!

## Need Some Glamour?

Dress up your Modern Finial: Add a 1" Crystal Band



**1" Crystal Band**  
QS100CRMEBAND  
5/8" W  
1 5/8" DIA

- Metal, only available in dark metal with inlaid crystals.
- Only fits 1" diameter pole.
- Not recommended for 1" Hand Drawn Traverse.

### How To Add Your Bling:

- 1 Buy a pair of 1" Modern Finials.
- 2 Buy two 1" Crystal Bands.
- 3 Slide each 1" Crystal Band onto the pole before installing finials.
- 4 Install finials. Slide Crystal Bands against finials and tighten set screws.

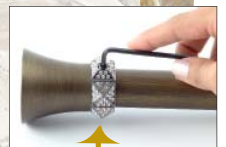

TIP:  
1" Crystal  
Band covers  
5/8" of pole!

QUICK SHIP Metal 1" .....> [Orders received by noon CST ship the same day!]



Elm with Cuff Finial, Laurence 3" Single Bracket, and 1" Metal Rings shown in Oil Rubbed Bronze.

# Transitional Metals

Versatile styling gives you more flexibility.

1" Transitional Metal Finials\* Compatible with 1" Hand Drawn Traverse System, see page 78.

**\*Remember:**  
Each finial on this page covers 3/8" of the pole. Finished pole length may need to be increased accordingly.



**Luna End Cap**  
QS100LUEC  
3/4" W  
1 1/2" DIA  
Rose Gold



**Ella with Cuff**  
QS100ELAFICU  
2 1/4" W  
1 3/8" DIA  
Antique Brass



**Lex with Cuff**  
QS100LXFICU  
2 1/2" W  
2" DIA  
Rose Gold



**Cole with Cuff**  
QS100COFICU  
4" W  
1 1/2" DIA  
Midnight



**Elm with Cuff**  
QS100EMFICU  
1 7/8" W  
2" DIA  
Oil Rubbed Bronze



**Nora with Cuff**  
QS100NOFICU  
2 3/4" W  
2 1/4" DIA  
Brushed Nickel



**Knox - Crystal with Cuff**  
QS100KNFICU  
2" W  
2 1/4" DIA  
Midnight



**Elm - Smoke Glass with Cuff**  
QS100EMFIGLCU  
1 7/8" W  
2" DIA  
Oil Rubbed Bronze



**Nora - Mercury Glass with Cuff**  
QS100NOFIGLCU  
2 3/4" W  
2 3/8" DIA  
Antique Brass

1" Transitional Metal Finials ARE AVAILABLE IN 5 QUICK SHIP METAL FINISHES:



BRUSHED NICKEL  
QSBN



MIDNIGHT  
QSMID



ROSE GOLD  
QSRG



ANTIQUE BRASS  
QSAB



OIL RUBBED BRONZE  
QSORB



# Today's Traditional

Refine your Transitional Finial: Add a Traditional Collar!  
*(Maintains compatibility with 1" Hand Drawn Traverse.)*

**TIP:**  
 Traditional Collar  
 also looks great  
 in a contrasting  
 finish like  
 Brushed Nickel!



## Traditional Collar

QSTRADCO

5/8" W

1 1/2" DIA

Brushed Nickel

- Available in any Quick Ship Metal finish.
- Can only be added to Metal Transitional Finials!

## How To Make It Traditional:

- 1 Buy a pair of 1" Transitional Finials.



- 2 Buy a pair of Traditional Collars.



- 3 Unscrew the finial from its Cuff.



- 4 Screw finial into the Traditional Collar. Screw Traditional Collar into the Cuff.



- 5 Attach the finial to the end of the pole by tightening the set screw on the Cuff.



**QUICK SHIP Metal 1"** ..... ➔ *[Orders received by noon CST ship the same day!]*

**1" Metal Holdbacks INCLUDE STEMS**  
*(Select 2", 4", or 6" stem projection.)*  
 Holdback projection indicates distance from wall to back of medallion. Sold in pairs.

**Blake - Mercury Glass**

3" DIA  
 2 3/8" thick  
 Rose Gold



2" projection	QSBKHB2
4" projection	QSBKHB4
6" projection	QSBKHB6

**Jem**

2 1/2" DIA  
 3/8" thick  
 Midnight



2" projection	QSJEHB2
4" projection	QSJEHB4
6" projection	QSJEHB6

**Mara**

3" DIA  
 7/8" thick  
 Oil Rubbed Bronze



2" projection	QSMARHB2
4" projection	QSMARHB4
6" projection	QSMARHB6

**Metal Holdback Stems**

Base: 2" DIA  
 Stem: 1/2" DIA  
 Rose Gold

2", 4", or 6" projection must be selected.

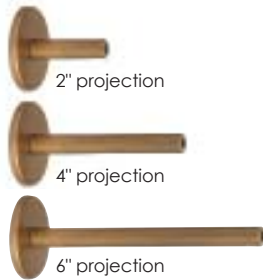

1" Metal Holdbacks ARE AVAILABLE IN 5 QUICK SHIP METAL FINISHES:



BRUSHED NICKEL  
 QSNB



MIDNIGHT  
 QSMID



ROSE GOLD  
 QSRG

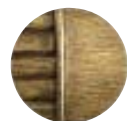

ANTIQUE BRASS  
 QSAB



OIL RUBBED BRONZE  
 QSORB

# 1" Metal Brackets, Poles, Rings & Accessories

## 1" Metal Brackets

Return indicates distance from wall to center of pole.



**Laurence 3" Single**  
 QS100LASBK  
 3/4" W  
 3 3/4" H backplate  
 3 1/2" return  
 Walnut



**Laurence 6" Single**  
 QS100LAS6BK  
 3/4" W  
 3 3/4" H backplate  
 6" return  
 Antique Brass



**Laurence 6" Double**  
 QS100LADBK  
 3/4" W  
 3 3/4" H backplate  
 6" front return  
 3" back return  
 Both cradles hold  
 1" diameter pole.  
 Oil Rubbed Bronze

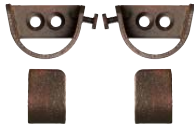

Front view when installed.

**1" Metal Inside Mount**  
 QS100MIBK  
 3/4" W  
 1 1/8" H  
 1 3/8" D  
 Oil Rubbed Bronze  
 (Sold in pairs)



**1" Metal Ceiling Mount**  
 QS100MCMBK  
 2" DIA ceiling plate  
 2 1/4" H  
 2 1/8" drop (distance from  
 ceiling to bottom of pole)  
 Rose Gold

## 1" Ring

Ring Drop indicates distance from bottom of pole to bottom of ring.



**1" Metal Ring**  
 QS100MRI  
 3/8" W  
 1 1/2" ID  
 1 7/8" OD  
 3/4" drop  
 Rose Gold

## 1" Accessories



**36" Clear Acrylic Wand**  
 QSAC36WAND  
 1/2" DIA  
 36" L  
 Acrylic, clear only



**48" Clear Acrylic Wand**  
 QSAC48WAND  
 1/2" DIA  
 48" L  
 Acrylic, clear only



**1" Hinged Resin Elbow**  
 QS100REL  
 1 1/8" DIA  
 3 1/4" overall length  
 1 3/8" length of each side  
 when bent  
 Midnight

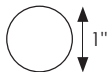

**1" Metal Pole**  
 QS100SM  
 Rose Gold

1" metal poles are sold in 2 foot increments. 2 foot minimum. Poles will be cut to specified lengths. Fall off will not be saved or shipped.

Custom cut metal poles are produced with steel threaded ends.

**Maximum continuous length is 12 feet.**

Every pole ships with a splicing screw.

Want the 1" Hand Drawn Traverse System instead of a 1" pole?



TURN THE PAGE → → → →

1" Metal Brackets, Poles, Rings & Accessories ARE AVAILABLE IN 5 QUICK SHIP METAL FINISHES:



BRUSHED NICKEL  
 QSBN



MIDNIGHT  
 QSMID



ROSE GOLD  
 QSRG



ANTIQUE BRASS  
 QSAB



OIL RUBBED BRONZE  
 QSORB

QUICK SHIP Metal 1" .....> [Orders received by noon CST ship the same day!]

# 1" Hand Drawn Traverse Finials

## Transitional

Transitional Metal Finials  
Located on page 74

## Make It Traditional

Add a Traditional Collar  
Located on page 75



1" Transitional Metal Finials and Traditional Collars ARE AVAILABLE IN 5 QUICK SHIP METAL FINISHES:



BRUSHED NICKEL  
QSBN



MIDNIGHT  
QSMID



ROSE GOLD  
QSRG



ANTIQUE BRASS  
QSAB



OIL RUBBED BRONZE  
QSORB



# 1" Hand Drawn Traverse System

**Single 1" Hand Drawn Traverse System**  
shown in Antique Brass Finish;  
Elm with Cuff Finial sold separately.

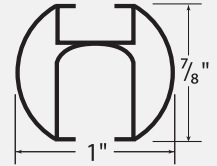
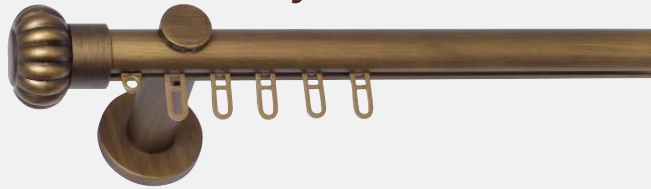

**Double 1" Hand Drawn Traverse System**  
shown in Brushed Nickel Finish;  
Cole with Cuff Finial and Luna End Cap  
sold separately.

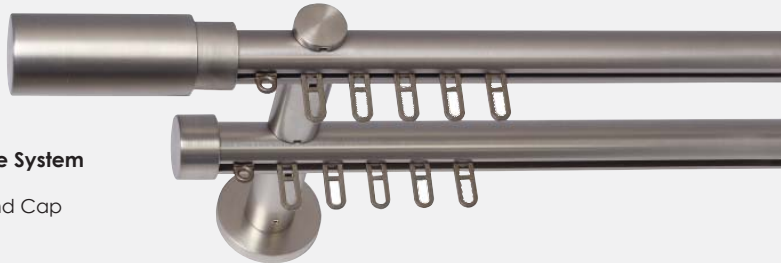

1" Hand Drawn Traverse System RECOMMENDED FOR LIGHTWEIGHT DRAPERIES

### 1" Hand Drawn Traverse System INCLUDES:

- Track(s): Continuous track available up to 8'; spliced lengths available up to 16'.
- Brackets
- Components: Glides and Glide Stop(s)\*
- 48" Clear Acrylic Wand(s)\*

*\*Note: Each Center Draw Track includes 2 Glide Stops and 2 Acrylic Wands. Each One-Way Draw Track includes 1 Glide Stop and 1 Acrylic Wand.*

### Finials sold separately.





- Transitional Finials must be ordered with all 1" Hand Drawn Traverse Systems.
- Only 1" Transitional Metal Finials can attach to the track.
- If a Traditional Collar is added to the 1" Transitional Finial, it will still fit the track.

**Maximum drapery weight - 2 lbs/ft.**

## Order in 3 Easy Steps:

### Step 1: Select your Draw.

### Step 2: Select your Bracket.

<p><b>Single Center Draw</b> QS100TR01</p> 	<p><b>Available Brackets</b> 3 1/2" Single 6" Single Ceiling Mount</p>
<p><b>Single One-Way Draw</b> QS100TR03</p> 	<p><b>Available Brackets</b> 3 1/2" Single 6" Single Ceiling Mount</p>
<p><b>Double Center Draw</b> QS100TR05</p> 	<p><b>Available Brackets</b> Double Bracket Ceiling Mount</p>
<p><b>Double One-Way Draw</b> QS100TR07</p> 	<p><b>Available Brackets</b> Double Bracket Ceiling Mount</p>

*Step 3: Purchase your Transitional Finials, sold separately. See page 74.*

1" Hand Drawn Traverse Systems ARE AVAILABLE IN 5 QUICK SHIP METAL FINISHES:



BRUSHED NICKEL  
QSBN



MIDNIGHT  
QSMID



ROSE GOLD  
QSRG



ANTIQUE BRASS  
QSAB



OIL RUBBED BRONZE  
QSORB

**QUICK SHIP Metal 1"** ..... ➔ [Orders received by noon CST ship the same day!]

### INCLUDED IN SYSTEM: 1" Hand Drawn Traverse Brackets

Available in 5 Quick Ship Metal finishes. Brackets must be installed every 3-4 feet. Bracket return indicates distance from wall to center of track. See System Quantity Chart below for quantity of brackets included with each system. Additional brackets may be ordered separately.

Bracket style must be specified on your order.



**1" Traverse 3 1/2" Single Bracket**  
 QS100TRSBK  
 2 1/8" DIA backplate  
 3 1/2" return  
 Antique Brass



**1" Traverse 6" Single Bracket**  
 QS100TRS6BK  
 2 1/8" DIA backplate  
 6" return  
 Oil Rubbed Bronze



**1" Traverse Ceiling Mount Bracket**  
 QS100TRCMBK  
 2 1/8" DIA ceiling plate  
 2 1/4" H  
 2 1/2" return  
 2 1/2" drop (distance from ceiling to bottom of track)  
 Rose Gold



**1" Traverse Double Bracket**  
 QS100TRDBK  
 2 1/8" DIA backplate  
 6" front return  
 3" back return  
 Brushed Nickel

### INCLUDED IN SYSTEM: 1" Hand Drawn Traverse Components

Components will be provided in the color that best matches the Quick Ship Metal finish, unless otherwise specified. See Component Color Chart below. See System Quantity Chart below for quantity of glides included with each system. Additional components may be ordered separately.

#### Standard Wheeled Glide

QS100GLIDE  
 3/8" W  
 1/4" drop (distance from bottom of track to bottom of eyelet interior when installed)



Bronze  
BZ



Champagne  
CH



Gold  
GO

White Glide may be substituted; please specify on order.



White  
WH

#### Glide Stop anchors the drapery panel at the end of the track.

QS100GSTOP  
 3/8" W  
 1/4" drop (distance from bottom of track to bottom of eyelet interior when installed)



Bronze  
BZ



Champagne  
CH



Gold  
GO

White Glide Stop may be substituted; please specify on order.



White  
WH



**Track Splicer**  
 QS100TRSPL  
 • connects the ends of two tracks  
 • installs into top channel  
 • included with all systems over 8'

#### 1" Hand Drawn Traverse System Component Color Chart



BRUSHED NICKEL  
QSBN



MIDNIGHT  
QSMID



ROSE GOLD  
QSRG

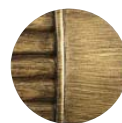

ANTIQUE BRASS  
QSAB



OIL RUBBED BRONZE  
QSORB

Component* Color	Champagne	Bronze	Gold	Gold	Bronze
White may be substituted (Must be specified on order.)	Yes	Yes	Yes	Yes	Yes

\*Components include Standard Wheeled Glide and Glide Stop.

### SYSTEM QUANTITY CHART

Quantity included per set will be based on total system length	Continuous Track Length							Spliced Track Length							
	2'	3'	4'	5'	6'	7'	8'	9'	10'	11'	12'	13'	14'	15'	16'
Glides (4 per foot, includes Glide Stop)	8	12	16	20	24	28	32	36	40	44	48	52	56	60	64
Brackets (1 per every 3-4 feet)	2	2	2	3	3	3	4	4	4	5	5	5	6	6	6

Quick Ship  
**Luxe Line**  
Hand Drawn  
Traverse System

Quick Ship LUXE LINE FINISHES



BRUSHED NICKEL  
QSLXBN



BLACK  
QSLXBK



ANTIQUE BRASS  
QSLXAB

**QUICK SHIP Luxe Line** .....> [*Orders received by noon CST ship the same day!*]



Single Luxe Line System with Vogue Finial and 3/7" Single Bracket, shown in Brushed Nickel.

Luxe Line Hand Drawn Traverse System RECOMMENDED FOR LIGHTWEIGHT DRAPERIES

**Luxe Line Finials** only fit Luxe Line Hand Drawn Traverse System. Sold Separately.



**Luxe End Cap**  
 QSLXEC  
 1/8" W  
 1 1/4" H  
 1/2" D  
 Black



**Haute**  
 QSLXHTFI  
 2 3/8" W  
 1 1/4" H  
 1/2" D  
 Brushed Nickel



**Chic**  
 QSLXCHF  
 2 3/8" W  
 1 1/4" H  
 1/2" D  
 Antique Brass



**Mode**  
 QSLXMOFI  
 2 3/8" W  
 1 1/4" H  
 1/2" D  
 Brushed Nickel



**Vogue**  
 QSLXVOFI  
 1 7/8" W  
 1 1/4" H  
 1/2" D  
 Antique Brass

**FUN FACT:**  
*These are the same finial—just reversed!*

Luxe Line Finials ARE AVAILABLE IN 3 QUICK SHIP LUXE LINE FINISHES:



BRUSHED NICKEL  
 QSLXBN



BLACK  
 QSLXBK



ANTIQUE BRASS  
 QSLXAB



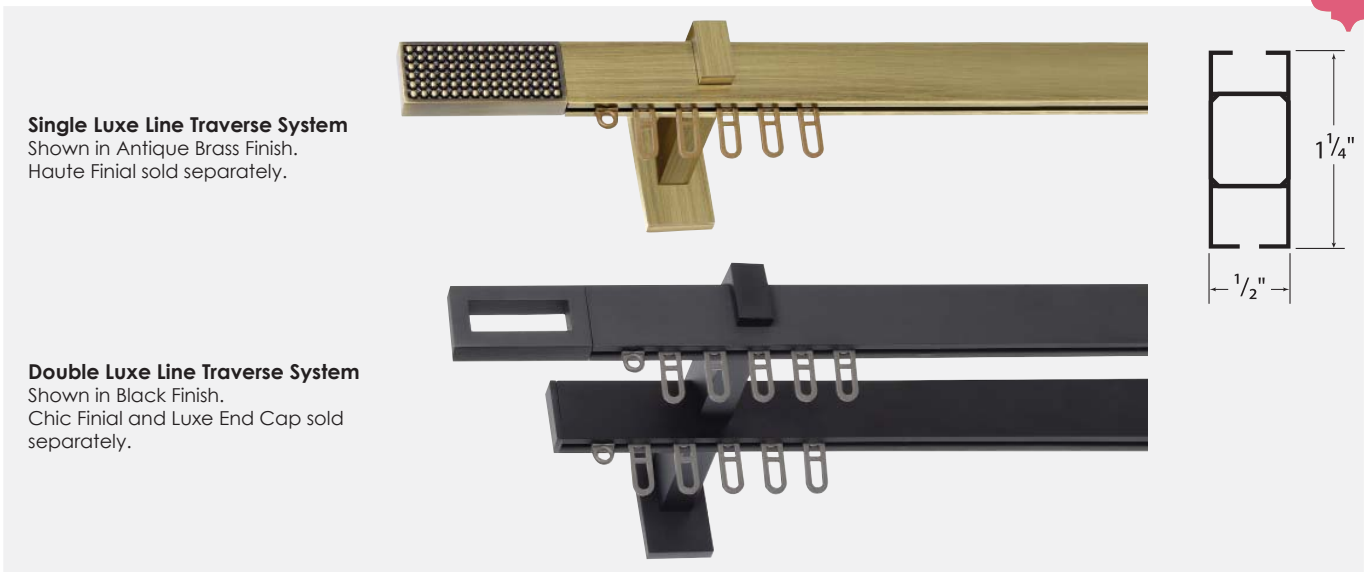

**Single Luxe Line Traverse System**  
Shown in Antique Brass Finish.  
Haute Finial sold separately.

**Double Luxe Line Traverse System**  
Shown in Black Finish.  
Chic Finial and Luxe End Cap sold separately.

Luxe Line Hand Drawn Traverse System RECOMMENDED FOR LIGHTWEIGHT DRAPERIES

**Luxe Line Hand Drawn Traverse System INCLUDES:**

- Track(s): Continuous track available up to 8'; spliced lengths available up to 16'.
- Brackets
- Components: Glides and Glide Stop(s)\*
- 48" Clear Acrylic Wand(s)\*

*\*Note: Each Center Draw Track includes 2 Glide Stops and 2 Acrylic Wands. Each One-Way Draw Track includes 1 Glide Stop and 1 Acrylic Wand.*

**Finials sold separately.**

- Luxe Line Finials must be ordered with all Luxe Line Hand Drawn Traverse Systems.
- Only Luxe Line Finials can attach to the track.

**Maximum drapery weight - 2 lbs/ft.**

*Order in 3 Easy Steps:*

*Step 1: Select your Draw.*

*Step 2: Select your Bracket.*

<p><b>Single Center Draw</b> QSLX01</p>	<p><b>Available Brackets</b> 3 1/2" Single 6 1/2" Single Ceiling Mount</p>
<p><b>Single One-Way Draw</b> QSLX03</p>	<p><b>Available Brackets</b> 3 1/2" Single 6 1/2" Single Ceiling Mount</p>
<p><b>Double Center Draw</b> QSLX05</p>	<p><b>Available Brackets</b> Double Bracket Ceiling Mount</p>
<p><b>Double One-Way Draw</b> QSLX07</p>	<p><b>Available Brackets</b> Double Bracket Ceiling Mount</p>

*Step 3: Purchase your Luxe Line Finials, sold separately. See page 82.*

Luxe Line Hand Drawn Traverse System IS AVAILABLE IN 3 QUICK SHIP LUXE LINE FINISHES:



BRUSHED NICKEL  
QSLXBN



BLACK  
QSLXBK



ANTIQUÉ BRASS  
QSLXAB

**INCLUDED IN SYSTEM: Luxe Line Hand Draw Traverse Brackets**

Available in 3 Quick Ship Luxe Line finishes. Brackets must be installed every 3-4 feet. Bracket return indicates distance from wall to center of track. See System Quantity Chart below for quantity of brackets included with each system. Additional brackets may be ordered separately.

Bracket style must be specified on your order.



**Luxe 3 1/2" Single Bracket**  
 QSLXTRSBK  
 2 7/8" H backplate  
 1 1/4" W  
 3 1/2" return  
 Brushed Nickel



**Luxe 6 1/2" Single Bracket**  
 QSLXTRS6BK  
 2 7/8" H backplate  
 1 1/4" W  
 6 1/2" return  
 Antique Brass



**Luxe Ceiling Mount Bracket**  
 QSLXTRCMBK  
 2 3/8" H  
 2 7/8" W ceiling plate  
 1 3/8" return  
 3" drop (distance from ceiling to bottom of track)  
 Brushed Nickel



**Luxe Double Bracket**  
 QSLXTRDBK  
 2 7/8" H backplate  
 1 1/4" W  
 6 1/2" front return  
 3 3/8" back return  
 Black

**INCLUDED IN SYSTEM: Luxe Line Hand Draw Traverse Components**

Components will be provided in the color that best matches the Quick Ship Luxe Line finish, unless otherwise specified. See Component Color Chart below. See System Quantity Chart below for quantity of glides included with each system. Additional components may be ordered separately.

**Standard Wheeled Glide**

QSLXGLIDE  
 3/8" W  
 3/4" drop (distance from bottom of track to bottom of eyelet interior when installed)



Bronze  
BZ



Champagne  
CH



Gold  
GO



White  
WH

White Glide may be substituted; please specify on order.

**Glide Stop** anchors the drapery panel at the end of the track.

QSLXGSTOP  
 3/8" W  
 1/4" drop (distance from bottom of track to bottom of eyelet interior when installed)



Bronze  
BZ



Champagne  
CH



Gold  
GO

White Glide Stop may be substituted; please specify on order.



White  
WH



**Track Splicer**  
 QSLXSPL

- Connects the ends of two tracks
- Installs into top channel
- included with all systems over 8'

**Luxe Line Hand Draw Traverse System Component Color Chart**



BRUSHED NICKEL  
QSLXBN



ANTIQUE BRASS  
QSLXAB



BLACK  
QSLXBK

Component* Color	Champagne	Gold	Bronze
*White may be substituted (Must be specified on order.)	Yes	Yes	Yes

\*Components include Standard Wheeled Glide and Glide Stop.

**SYSTEM QUANTITY CHART**

Quantity included per set will be based on total system length	Continuous Track Length							Spliced Track Length							
	2'	3'	4'	5'	6'	7'	8'	9'	10'	11'	12'	13'	14'	15'	16'
Glides (4 per foot, includes Glide Stop)	8	12	16	20	24	28	32	36	40	44	48	52	56	60	64
Brackets (1 per every 3-4 feet)	2	2	2	3	3	3	4	4	4	5	5	5	6	6	6

Quick Ship  
Wood and Resin  
1 3/8"

Quick Ship WOOD AND RESIN FINISHES



PLATINUM  
QSPL



WALNUT  
QSWAL



ROSE GOLD  
QSRG



ANTIQUE BRASS  
QSAB



OIL RUBBED BRONZE  
QSORB

# Moderate Size. Big Statement.

With poles small enough for a rod pocket and finials that make a BIG statement, 1 3/8" may be your perfect size.



Lillian - Mercury Glass Finial shown in Platinum.

## 1 3/8" Resin Finials



**Lowell End Cap**  
 QS138LOEC  
 1" W  
 1 3/4" DIA  
 Walnut



**Bradford**  
 QS138BRFI  
 3 1/4" W  
 2 1/4" DIA  
 Walnut



**Harper**  
 QS138HAFI  
 3" W  
 2 3/4" DIA  
 Platinum



**Rose - Crystal**  
 QS138ROFI  
 2 3/4" W  
 2 3/4" DIA  
 Antique Brass

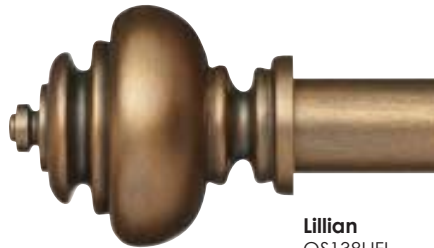

**Lillian**  
 QS138LIFI  
 4" W  
 3 3/8" DIA  
 Rose Gold



**Lane**  
 QS138LAFI  
 3 1/2" W  
 3 3/8" DIA  
 Rose Gold



**June**  
 QS138JUFI  
 2 3/4" W  
 2 3/4" DIA  
 Oil Rubbed Bronze



**Lillian - Mercury Glass**  
 QS138LIFIGL  
 4" W  
 3 1/2" DIA  
 Platinum



**Easton**  
 QS138EAFI  
 2 3/2" W  
 3 1/2" DIA  
 Oil Rubbed Bronze

*Quick Ship Finishes work beautifully with natural materials and earthy textures.*

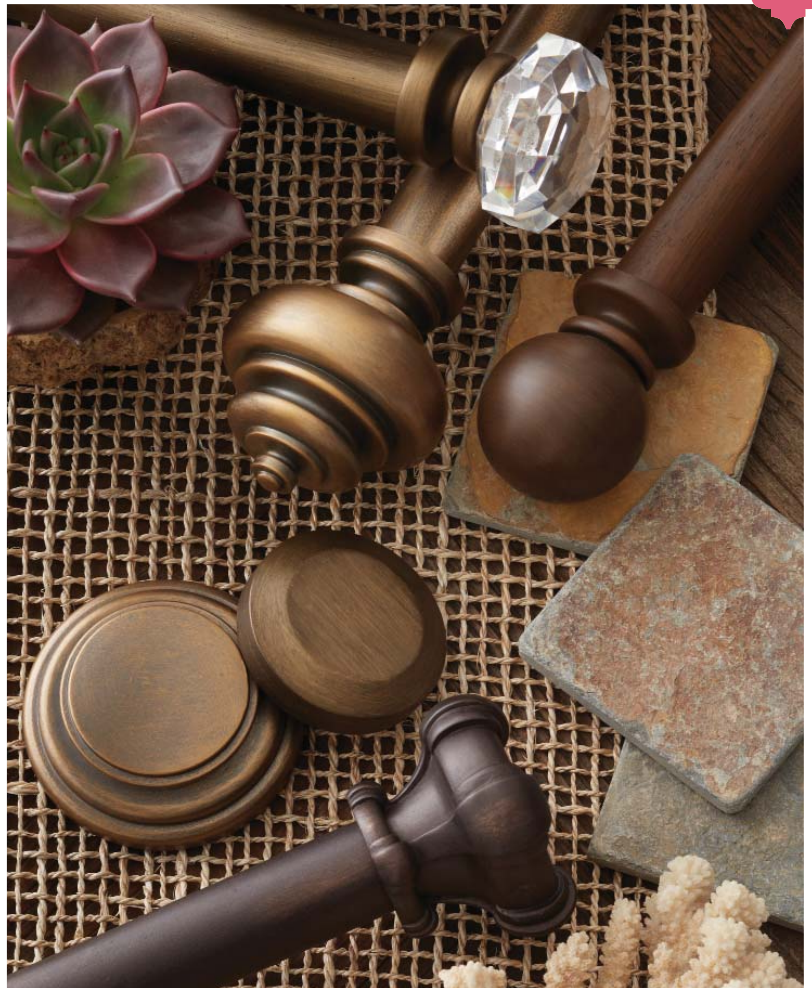

**1 3/8" Holdbacks INCLUDE STEMS**

*(Select 2", 4", or 6" stem projection.)*

Holdback projection indicates distance from wall to back of medallion. Sold in pairs.

**Metal Holdbacks** include Metal Holdback Stems

**Blake - Mercury Glass**  
3" DIA  
2 3/8" thick  
Rose Gold



2" projection	QSBKHB2
4" projection	QSBKHB4
6" projection	QSBKHB6

**Metal Holdback Stems**

Base: 2" DIA  
Stem: 1/2" DIA  
Rose Gold



2", 4", or 6" projection must be selected.

**Resin Holdbacks** include Resin Holdback Stems

**Clark**  
3" DIA  
1" thick  
Antique Brass



2" projection	QSCKHB2
4" projection	QSCKHB4
6" projection	QSCKHB6

**Trudy**  
4 3/4" DIA  
3/4" thick  
Walnut



2" projection	QSTRHB2
4" projection	QSTRHB4
6" projection	QSTRHB6

**Brooks**  
4" DIA  
1 1/4" thick  
Rose Gold



2" projection	QSBRHB2
4" projection	QSBRHB4
6" projection	QSBRHB6

**Miranda**  
5" DIA  
1 1/2" thick  
Platinum



2" projection	QSMIHB2
4" projection	QSMIHB4
6" projection	QSMIHB6

**Resin Holdback Stems**

Base: 3 5/8" DIA  
Stem: 3/4" DIA  
Platinum

2", 4", or 6" projection must be selected.



**1 3/8" Finials & Holdbacks ARE AVAILABLE IN 5 QUICK SHIP WOOD AND RESIN FINISHES:**



PLATINUM  
QSPL



WALNUT  
QSWAL



ROSE GOLD  
QSRG



ANTIQU BRASS  
QSAB



OIL RUBBED BRONZE  
QSORB

**1 3/8" Brackets, Poles, Rings & Accessories**

**1 3/8" Metal Brackets**

Return indicates distance from wall to center of pole.



**Winston 3" Single**  
 QS138WSSBK  
 3/4" W  
 3 3/4" H backplate  
 3 1/2" return  
 Walnut



**Winston 6" Single**  
 QS138WSS6BK  
 3/4" W  
 3 3/4" H backplate  
 6" return  
 Antique Brass



**Winston 6" Double**  
 QS138WSDBK  
 3/4" W  
 3 3/4" H backplate  
 6" front return  
 3" back return  
 Both cradles hold  
 1 3/8" diameter pole.  
 Oil Rubbed Bronze



**1 3/8" Metal Inside Mount**  
 QS138MIBK  
 1" W  
 1 1/4" H  
 2 1/2" D  
 Platinum  
 (Sold in pairs)

Front view when installed.



**1 3/8" Metal Ceiling Mount**  
 QS138MCMBK  
 2" DIA ceiling plate  
 2 3/4" H  
 2 7/8" drop (distance from ceiling to bottom of pole)  
 Rose Gold

**1 3/8" Resin Brackets**

Return indicates distance from wall to center of pole.



**William 3" Single**  
 QS138WISBK  
 1" W  
 3 1/2" H backplate  
 3 3/4" return  
 Walnut



**William 6" Single**  
 QS138WIS6BK  
 1" W  
 3 1/2" H backplate  
 6 3/4" return  
 Rose Gold



**William 6" Double**  
 QS138WIDBK  
 1" W  
 3 3/8" H backplate  
 6 3/4" front return  
 3 3/4" back return  
 Both cradles hold  
 1 3/8" diameter pole.  
 Antique Brass

**1 3/8" Rings**

Drop indicates distance from bottom of pole to bottom of ring.



**1 3/8" Wood Ring**  
 QS138WRI  
 1/2" W  
 1 3/4" ID  
 2 5/8" OD  
 3/4" drop  
 Platinum



**1 3/8" Metal Ring**  
 QS138MRI  
 3/8" W  
 1 3/4" ID  
 2 1/4" OD  
 1/2" drop  
 Rose Gold

**1 3/8" Accessories**



**36" Clear Acrylic Wand**  
 QSAC36WAND  
 1/2" DIA  
 36" L  
 Acrylic, clear only



**48" Clear Acrylic Wand**  
 QSAC48WAND  
 1/2" DIA  
 48" L  
 Acrylic, clear only



**1 3/8" Hinged Resin Elbow**  
 QS138REL  
 1 3/8" DIA  
 3 7/8" overall length  
 1 1/8" length each side when bent  
 Oil Rubbed Bronze

**1 3/8" Wood Poles**



**Smooth**  
 QS138SM  
 Rose Gold



1 3/8" smooth and fluted wood poles are sold in 2 foot increments. 2 foot minimum. Poles will be cut to specified lengths. Fall off will not be saved or shipped.

**Maximum continuous length is 12 feet.**  
 Every pole ships with a splicing screw.



**Fluted**  
 QS138FL  
 Rose Gold



1 3/8" Brackets, Poles, Rings & Accessories ARE AVAILABLE IN 5 QUICK SHIP WOOD AND RESIN FINISHES:



PLATINUM  
 QSPL



WALNUT  
 QSWAL



ROSE GOLD  
 QSRG



ANTIQUE BRASS  
 QSAB



OIL RUBBED BRONZE  
 QSORB

Quick Ship  
Wood and Resin  
2 1/4"

Quick Ship WOOD AND RESIN FINISHES



PLATINUM  
QSPL



WALNUT  
QSWAL



ROSE GOLD  
QSRG



ANTIQUE BRASS  
QSAB



OIL RUBBED BRONZE  
QSORB

QUICK SHIP Wood and Resin 2 1/4" .....> [Orders received by noon CST ship the same day!]

# Large Scale. Fine Details.

With an update on tradition and an upgrade in size, 2 1/4" adds sophistication to any window.



Beatrice Resin Finial, William 3 1/2" Single Bracket, and Wood Rings shown in Walnut.

## 2 1/4" Resin Finials



**Brinley End Cap**  
 QS214BREC  
 1 1/2" W  
 2 3/4" DIA  
 Antique Brass

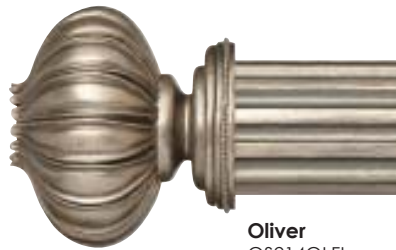

**Oliver**  
 QS214OLFI  
 3 3/4" W  
 3 3/4" DIA  
 Platinum

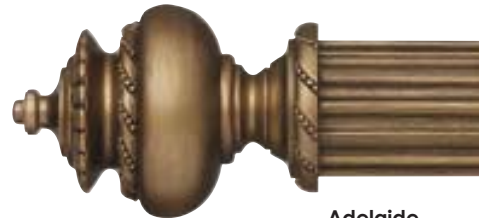

**Adelaide**  
 QS214ADFI  
 5" W  
 3 1/2" DIA  
 Antique Brass



**Hazel - Crystal**  
 QS214HZFI  
 2 3/4" W  
 3 1/4" DIA  
 Walnut



**Fiona**  
 QS214FIFI  
 4" W  
 5 1/4" DIA  
 Oil Rubbed Bronze

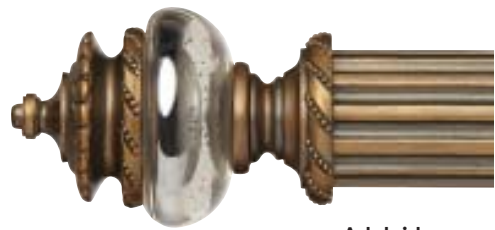

**Adelaide - Mercury Glass**  
 QS214ADFIGL  
 5" W  
 3 3/8" DIA  
 Rose Gold



**Stella**  
 QS214STFI  
 2 1/4" W  
 3 1/4" DIA  
 Platinum



**Beatrice**  
 QS214BEFI  
 4 1/4" W  
 4" DIA  
 Walnut



**Edward**  
 QS214EDFI  
 4 1/4" W  
 3 1/4" DIA  
 Oil Rubbed Bronze



*Elegant and dramatic,  
large scale finials provide  
instant distinction  
to any window.*



**2 1/4" Holdbacks INCLUDE STEMS**

*(Select 2", 4", or 6" stem projection.)*

Holdback projection indicates distance from wall to back of medallion. Sold in pairs.

**Metal Holdbacks** include Metal Holdback Stems

**Blake - Mercury Glass**

3" DIA  
2 3/8" thick  
Rose Gold



2" projection	QSBKHB2
4" projection	QSBKHB4
6" projection	QSBKHB6

**Metal Holdback Stems**

Base: 2" DIA  
Stem: 1/2" DIA  
Rose Gold



2", 4", or 6" projection must be selected.

**Resin Holdbacks** include Resin Holdback Stems

**Clark**

3" DIA  
1" thick  
Antique Brass



2" projection	QSCKHB2
4" projection	QSCKHB4
6" projection	QSCKHB6

**Trudy**

4 3/4" DIA  
3/4" thick  
Walnut



2" projection	QSTRHB2
4" projection	QSTRHB4
6" projection	QSTRHB6

**Brooks**

4" DIA  
1 1/4" thick  
Rose Gold



2" projection	QSBRHB2
4" projection	QSBRHB4
6" projection	QSBRHB6

**Miranda**

5" DIA  
1 1/2" thick  
Platinum



2" projection	QSMIHB2
4" projection	QSMIHB4
6" projection	QSMIHB6

**Resin Holdback Stems**

Base: 3 5/8" DIA  
Stem: 3/4" DIA  
Platinum

2", 4", or 6" projection must be selected.



**2 1/4" Finials & Holdbacks ARE AVAILABLE IN 5 QUICK SHIP WOOD AND RESIN FINISHES:**



PLATINUM  
QSPL



WALNUT  
QSWAL



ROSE GOLD  
QSRG



ANTIQUE BRASS  
QSAB



OIL RUBBED BRONZE  
QSORB

**2 1/4" Brackets, Poles, Rings & Accessories**

**2 1/4" Metal Brackets**

Return indicates distance from wall to center of pole.



**Harlan 3" Single**  
 QS214HASBK  
 3/4" W  
 3 3/4" H backplate  
 4 1/8" return  
 Oil Rubbed Bronze



**Harlan 6" Single**  
 QS214HAS6BK  
 3/4" W  
 3 3/4" H backplate  
 6" return  
 Platinum



**Harlan 6" Double**  
 QS214HADBK  
 3/4" W  
 3 3/4" H backplate  
 6" front return  
 2 3/8" back return  
 Front cradle holds 2 1/4" diameter pole; back cradle holds 1 3/8" diameter pole.  
 Walnut



Front view when installed.

**2 1/4" Metal Inside Mount**  
 QS214MIBK  
 1" W  
 1 1/8" H  
 2 7/8" D  
 Antique Brass  
 (Sold in pairs)



**2 1/4" Metal Ceiling Mount**  
 QS214MCMBK  
 1" W x 3 1/4" D ceiling plate  
 1" W  
 3 3/4" H  
 3 1/4" D  
 3 3/8" drop (distance from ceiling to bottom of pole)  
 Oil Rubbed Bronze

**2 1/4" Resin Brackets**

Return indicates distance from wall to center of pole.



**2 1/4" William 3" Single**  
 QS214WISBK  
 1" W  
 4" H backplate  
 4 1/8" return  
 Platinum



**2 1/4" William 6" Single**  
 QS214WIS6BK  
 1" W  
 4" H backplate  
 7 1/8" return  
 Walnut



**2 1/4" William 6" Double**  
 QS214WIDBK  
 1" W  
 3 3/8" H backplate  
 7 1/8" front return  
 3 1/4" back return  
 Front cradle holds 2 1/4" diameter pole; back cradle holds 1 3/8" diameter pole.  
 Rose Gold

**2 1/4" Rings**

Ring Drop indicates distance from bottom of pole to bottom of ring.



**2 1/4" Wood Ring**  
 QS214WRI  
 1/2" W  
 2 5/8" ID  
 3 3/8" OD  
 7/8" drop  
 Antique Brass



**2 1/4" Metal Ring**  
 QS214MRI  
 1/4" W  
 2 1/2" ID  
 3" OD  
 1/2" drop  
 Oil Rubbed Bronze

**2 1/4" Accessories**



**36" Clear Acrylic Wand**  
 QSAC36WAND  
 1/2" DIA  
 36" L  
 Acrylic, clear only



**48" Clear Acrylic Wand**  
 QSAC48WAND  
 1/2" DIA  
 48" L  
 Acrylic, clear only



**2 1/4" Hinged Resin Elbow**  
 QS214REL  
 2 3/8" DIA  
 5 1/8" overall length  
 2 1/4" length each side when bent  
 Antique Brass

**2 1/4" Wood Poles**



**Smooth**  
 QS214SM  
 Platinum



**Fluted**  
 QS214FL  
 Platinum

2 1/4" smooth and fluted wood poles are sold in 2 foot increments. 2 foot minimum. Poles will be cut to specified lengths. Fall off will not be saved or shipped.

**Maximum continuous length is 12 feet.**

Every pole ships with a splicing screw.

**2 1/4" Quick Ship Finials, Fascia, and Finishes available in Corded and Motorized Traverse. 10 - 15 DAY LEAD TIME. SEE PAGES 61 - 68.**



**Pinch Pleat**



**Ripplefold® Style**

2 1/4" Brackets, Poles, Rings & Accessories ARE AVAILABLE IN 5 QUICK SHIP WOOD AND RESIN FINISHES:



PLATINUM  
 QSPL



WALNUT  
 QSWAL



ROSE GOLD  
 QSRG



ANTIQUE BRASS  
 QSAB



OIL RUBBED BRONZE  
 QSORB

## General Info

PORTFOLIO FINISHES	
AM	Amulet
AND	Andiron
AG	Antique Gold
AGL	Antique Gold Leaf
AB	Art Bronze
BW	Barnwood
BL	Black
CIN	Cinnamon
DC	Dark Chocolate
ET	Eternal
FL	Firelight
GR	Goldenrod
GOS	Gossamer
HA	Halo
JA	Java
LIN	Linen
MK	Mink
ML	Moonlight
MYS	Mystic
NAB	New Age Bronze
PAR	Parchment
SH	Shimmer
SM	Silver Maple
SPW	Spicewood
SPG	Spun Gold
ST	Starlet
TIM	Timber
TTM	Titanium
URB	Urban Bronze
WH	White
PTH PERFECT MATCH™ FINISHES	
PPMEF	Eggshell Sheen Level
PPMHGF	High-Gloss Sheen Level
PPMGLITTER	Glitter Highlights
PPMGOLD	Gold Highlights
PPMROSEGOLD	Rose Gold Highlights
PPMSILVER	Silver Highlights
QUICK SHIP FINISHES	
1" METAL	
QSAB	Antique Brass
QSBN	Brushed Nickel
QSMID	Midnight
QSORB	Oil Rubbed Bronze
QSRG	Rose Gold
LUXE LINE	
QSLXAB	Antique Brass
QSLXBN	Brushed Nickel
QSLXBK	Black
WOOD AND RESIN 1 3/8" and 2 1/4"	
QSAB	Antique Brass
QSORB	Oil Rubbed Bronze
QSPL	Platinum
QSRG	Rose Gold
QSWAL	Walnut

### Finishes

Finishes with antiquing, dusting, or glazing will vary from product to product depending on the level of detail. Areas with deeper recesses will appear darker than smooth areas.

For the best possible finish match, refer to the 2014 Paris Texas Hardware Finish Chips. These chips have smooth, fluted, and carved detailed areas, enabling you to see the beautiful shadings and highlights that make our finishes so special.

Strike-offs: For an additional fee, Paris Texas Hardware can provide a sample of your Portfolio or PTH Perfect Match™ finish on any wood or metal pole as requested. Customer approval of the strike-off sample is required before production will begin.

Touch up paint can be sent to the customer on request, for an additional charge.

### Materials

Some finials, brackets, holdbacks, and rings are made of resin composite materials. Resin may be damaged by cutting, drilling, or attempting to alter the size or shape of products. Some items are made of cast aluminum or stamped steel. Wood poles and wood rings are made of various hardwoods. Metal poles and metal rings are made of steel.

### Poles & Rods

Poles may be spliced together using a dowel splicing screw, which is included with each pole. We recommend a center support bracket for pole lengths in excess of four feet. We cannot guarantee against sagging caused by unsupported spans greater than our recommended four feet.

### Finials & Holdbacks

**All finials and holdbacks are sold as pairs.** Most resin finial bases have a 1/8" recess for a clean pole fit. Resin finials are fitted with a dowel screw that may not be removed without damaging the finial

### Brackets

**Brackets are sold individually.** Depending on the style of the bracket, there are three wall mounting styles; key lock, round mounting plate, or front drill. Some heavier treatments may require stronger fasteners (mollies and screws) than those included with the brackets. Brackets should be installed securely into wall studs.

### Rings

**Rings are sold individually.** Eyelets are not detachable from resin rings. Excessive movement of rings on the top of the pole will naturally abrade the finish. We discourage using heavy treatments with the 1" resin rings. We recommend three to four rings per foot of finished pole length, or six to seven rings per width of fabric.

## GENERAL INFO

### Production Time

Purchase orders are processed once they are received by Paris Texas Hardware. Incomplete information will delay processing and shipping. Quick Ship collections are in stock and ship within 24 hours. Quick Ship orders received before noon CST ship the same day. Portfolio custom collection is hand finished and ships within 10-15 business days.

### Corded and Motorized Traverse Systems

Traverse systems are available for 2" and 2¼" Portfolio and 2¼" Quick Ship Wood and Resin. Production time for traverse system orders is 10-15 business days. Please refer to pages 61-68 for available pole sizes and finishes.

### Pricing and Terms

Pricing found in the Paris Texas Hardware Price List are our Suggested Retail Prices. Prices are subject to change without notice. Prices are quoted exclusive of Freight and Packaging. The Buyer should always inspect the product upon receipt.

IMPORTANT: Please note that your order will be placed with an authorized Paris Texas Hardware Distributor. While most of the following will generally apply, your distributor may have terms and conditions of the sale that will vary from what is stated here.

### Returns, Changes, and Cancellations

All Portfolio and PTH Perfect Match™ products are custom painted and may not be returned. Orders may not be changed or cancelled once production has begun.

Quick Ship items may be returned if poles are uncut and all products are received in sellable condition. A restocking fee of 40% will apply and the customer will prepay freight. All returns must be authorized by the Paris Texas Hardware customer service department, and are authorized at our discretion, given the circumstances and nature of each order. A Return Authorization Number (RA#) must be issued by customer service, and the RA# must be noted on all return packages. Return Credit is issued on returned goods that are inspected and deemed undamaged. Customers should exercise care to adequately package return goods. Return Credit will not be issued for unauthorized returns or damaged returns.

### Shipping

All hardware orders are shipped FOB Dallas, Texas. Poles over 100" MUST be shipped by common carrier. Please see the Paris Texas Hardware Retail Price List for applicable Freight and Packaging fees.

### Damaged Goods and Freight Claims

Immediately upon receipt, your order should be inspected to ensure that there is no concealed damage from shipping. To report a claim, contact your Paris Texas Hardware distributor. Damage and freight claims must be made within 15 days of receipt of goods. Claims reported after 15 days will not be accepted. To expedite the claim process, please provide your distributor with the following information: purchase order number, Paris Texas Hardware order number, shipping phone number and address, and a complete list of damaged items. Freight companies require all packaging materials and damaged items to be kept for inspection. Merchandise damaged in shipping will be replaced. Our policy is that we replace damaged product per the original order.

Please note on the Bill of Lading If there is any possibility of concealed damage.

### Installation

We recommend using a professional installer. Installation hardware is included. The fasteners (screws and mollys) may not be appropriate for every installation or wall material. Brackets and holdbacks should be installed securely into wall studs when possible. Paris Texas Hardware will not assume responsibility for damages incurred by improperly mounted or inadequately supported hardware.

— *Special thanks to Duralee and RM Coco for providing many of the gorgeous fabrics featured in our catalog.*